

product description: Box designated for distribution systems with voltage up to 400 V
 For installation in insulated building facades 120-300 mm thick
 Use as a distribution box, for measuring the lightning conductor terminal and other applications as required by the customer
 Eliminates thermal bridges
 Box depth is adjustable
 The kit contains the box, tube, inner and outer insulation, assembly leaflet, V 180 flat cover and stainless bolts
 When installing on exterior plaster, it is recommended to seal the lid with silicone, or rubber-based window seal (IP 44)
 Robust design
 Protected by European industrial design
 Installation video at www.kopos.cz

material: PC ABS, halogen-free
 color: gray
 self-snuffing: yes, within 30 s
 temperature resistance: -25 - +60 °C
 flaming loop test: 850 °C
 fire class for underlying material: A1-F
 protection types: IP 30
 protection types: IP 44 - seal under the lid, plaster roughness up to 2 mm
 weight: 775 g
 meets the requirements: ČSN EN 60670-1, ČSN EN IEC 60670-1 ed. 2:21
 storage: ČSN 64 0090

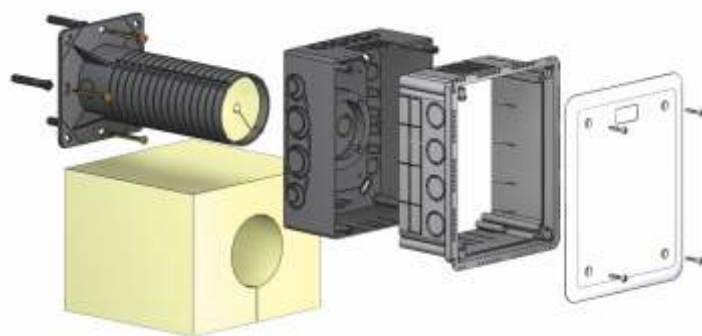

KUZ-VI_KB - individual boxes packed in separate cardboard

accessories: terminal plate S-KSK 2
 screwless terminal plates TYP015, TYP016, TYP017, TYP018
 support trunking TS35